



Flash Floods



Severe Storms



Water Main
Break



Swelling Rivers



Hurricanes



Construction



M A N U A L



Manufactured by MegaSecur



TABLE OF CONTENTS

- How it Works2
- Golden Rules to Follow3
- Make a Corner or Curving the Water-Gate4
- Connecting Water-Gates Together6
- Securing the Ends Of Water-Gates7
- Protecting an Entrance7
- Adherence of the Water-Gate Installed on a Smooth Surface7
- Elimination of Water Infiltrations Under the Barrier8
- Importance of Not Tying The Water-Gate to the Ground.....8
- Importance of Having Water Pumps8
- Special Considerations9
- Calculation of Installation Time10
- Folding Up the Water-Gate for Storage11
- Maintenance, Storage, Repairs & Warranty12
- Storage Deployment Crates12
- Technical Fabric Specifications13
- Technical Information14
- Environmental Footprint15
- Frequently Asked Questions15
- Notes & Maintenance Log18

RESPONSIBILITY

Before using your Water-Gate, it is essential to read the entire user guide and conduct at least one preliminary test. This is meant to ensure you master all the steps required for installing the Water-Gate. The vendor and manufacturer shall in no way be responsible for faulty installation and/or faulty use of the Water-Gate.

TESTED & APPROVED:



US ARMY
CORPS OF ENGINEERS

Testing Details:

- Water-Gate System was 39in High x 83ft Long
- Deployment took only 8.6 Man Hours
- Disassembly only took 2.3 Man Hours
- Zero Repairs Needed

“Only Portable Perimeter Flood Protection Barrier tested, that passed the Wave Test without causing any damage to the product itself.”



FM Approved Models:
QDWGWL-3930, QDWGWL-3950, QDWGWL-5030,
QDWGWL-5050, QDWGWL-6030, QDWGWL-6050

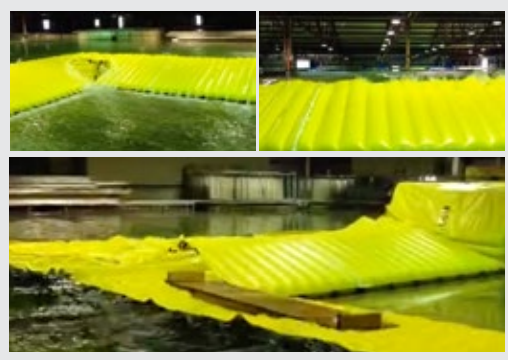

HOW THE WATER-GATE WORKS

Water accumulates inside the barrier and exerts pressure on the bottom of the fabric, which keeps the barrier in place. The speed or direction of the incoming water is not important, as it is the water pressure that causes the barrier to open up.

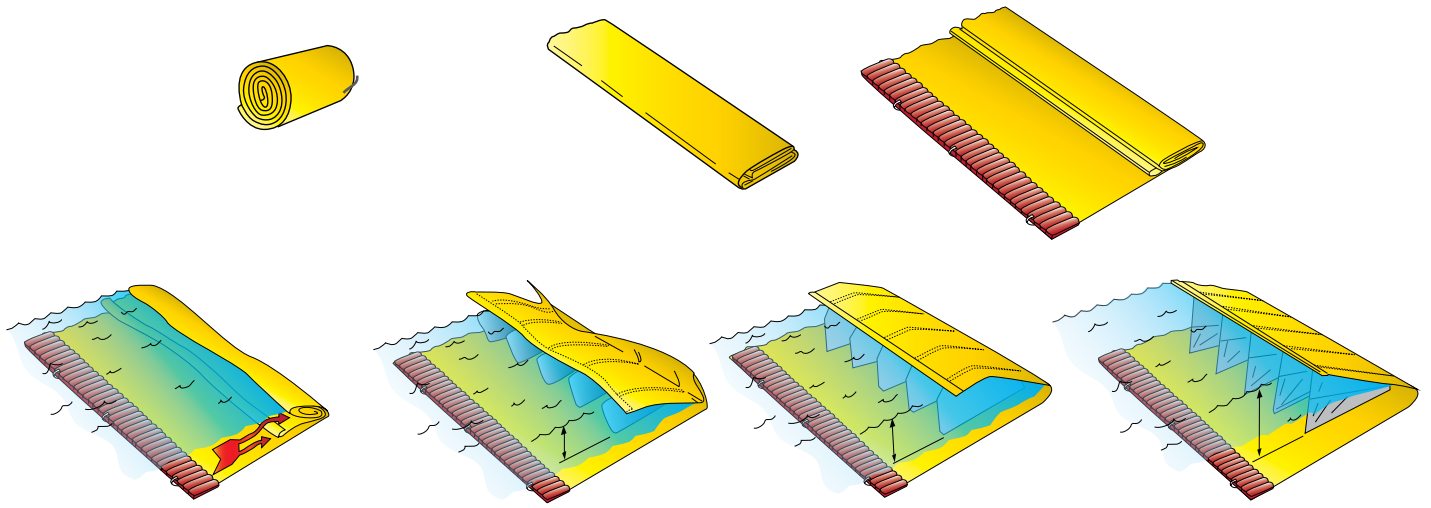

WATER HOLDING BACK WATER

The Water-Gate barrier has a ratio of 4:1 meaning the surface of the barrier on the ground is 4 times greater than its water retention height. It has 4 times more vertical thrust (toward the ground) than horizontal thrust, allowing for good adherence. Typically, in order for water to be able to hold back water on most surfaces such as asphalt or grass, a ratio of 1 to 2½ is sufficient to ensure safety. With a ratio of 4:1 the Water-Gate barrier is very safe and the chances of it slipping are very slim. The wider the barrier is the less likely it is to slip. The Water-Gate water barrier is 33% safer than required.

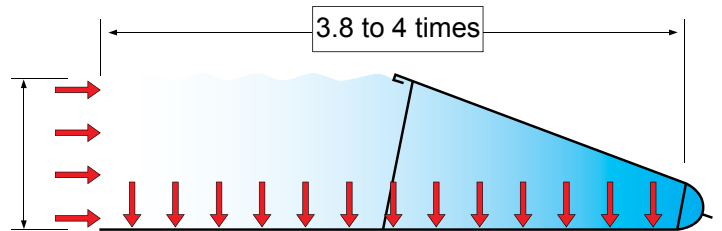

For areas where space is a concern, we also offer a 3:1 ratio, still higher than the recommended 2.5:1

MAIN FEATURES OF THE WATER-GATE

Designed for flood control.

- A** - Polyester fabric coated with super heavy-duty, abrasion resistant PVC suitable for use on all types of surfaces.
- B** - Stretched partitions made of 100% woven polyethylene
- C** - Polypropylene straps to ease in handling
- D** - Galvanized metal plate ballast weights held in polyester netting sewn to the Water-Gate.
- E** - Polypropylene straps to ease in handling
- F** - Open area behind partition to allow for water to flow through evenly

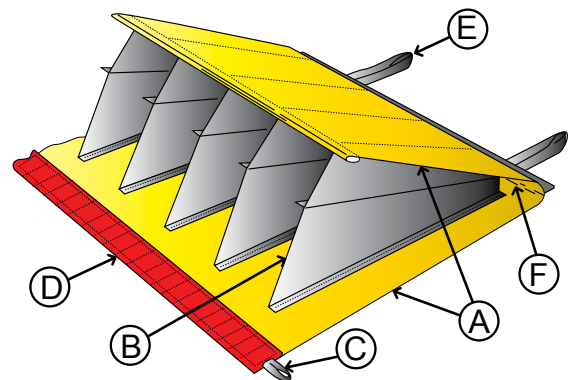

GOLDEN RULES TO FOLLOW

Pump the water at the back of the barrier



It's important to leave a reasonable amount of space (approximately 2ft) between the building and the back of the Water-Gate. Leave room to install a water pump and be able to move freely. Rain, storm water & water seeping underneath the Water-Gate should not be left to accumulate behind the barrier. Having too much water behind the unit can cause unbalancing issues, so be sure to pump out the excess water.

Place an even amount of weight at the front



Do not tie the Water-Gate to the ground, as it uses the weight of the water to stop oncoming water. However, it is very important to place weights along the length of the front flap where ever the surface is uneven, to minimize water infiltrations underneath the Water-Gate and keep it on the ground.

Prevent water from accumulating under the Water-Gate



Remove all objects likely to create water accumulating under the barrier flap. The barrier is designed to stay in place on all surfaces such as asphalt, gravel, lawns and concrete paving blocks, but if there is too much water under the flap, the Water-Gate will not adhere as well and may slip.

Never try to contain a leak at the back of the Water-Gate



Trying to contain a leak at the back of the Water-Gate will create a pool of water and make the Water-Gate unstable. If there are significant leaks, stop the water from coming in at the front of the barrier. It is expected to leak 1/2 gallon, per minute, per yard - so please plan accordingly.

INSTALLATION ON A MANHOLE

Under no circumstances should you install your water barrier on a manhole. If your water barrier must be set up in a location where there is a manhole, the best solution is to install the barrier behind the manhole, so in the event the manhole overflows, it will flow into the Water-Gate. You can also set it up in front but you will have to close up the manhole as to not create flooding behind the Water-Gate unit. We offer our Water Plug for such situations.

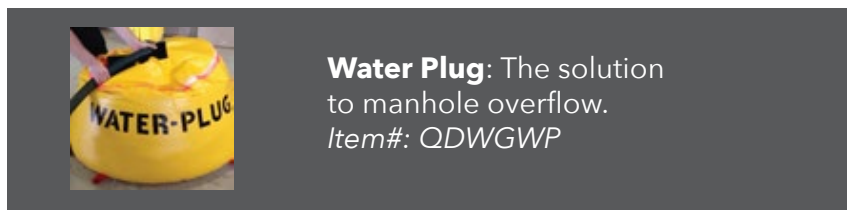

Water Plug: The solution to manhole overflow.
Item#: QDWGWP

NEVER SET THE BACK OF THE WATER-GATE AGAINST A WALL

If you set the back of the water barrier against a wall, water will slowly accumulate between the wall and the Water-Gate and water will then seep into your building. This will also have the effect of destabilizing the Water-Gate.



Recommended



Not Recommended



MAKE A CORNER OR CURVING THE WATER-GATE

Water-Gates can be shaped to contain or repel water. Although containing water is more of a challenge, as there is more seepage.



Method used to contain water



Method used to repel water

1. Square corner to **REPEL** the water:



A - Completely unfold the Water-Gate.



B - Place weights on the front flap of the Water-Gate as a pivot point and turn unit to the desired angle.



C - Pull the material up on each side so that it can easily open from the front, then fold the back edges & lay on top



D - Weights need to be added to the front folded corner to ensure that water does not seep underneath.

2. Square corner to **CONTAIN** the water:

Please note that containing water with the Water-Gate system can be difficult & often results in excessive seepage.

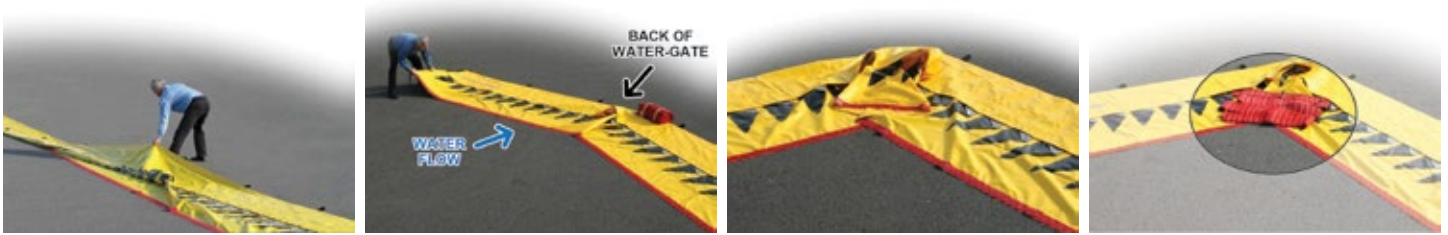

A - Completely unfold the Water-Gate.

B - Place weights at the back of the Water-Gate as a pivot point and curve the barrier to the angle required to contain the water.

C - From the red weighted side, pull the material up in the middle, spread it out & place on top. Lift the upper back walls on both sides to be sure that water can enter.

D - Remove the pivot weight from the back edge & place them on the front edge to prevent infiltration under the folds

3. Making a round curve to **REPEL** the water:



A - Completely unfold the Water-Gate.

B - Give the Water-Gate the desired curve.

C - In the event there are pockets from curving the barrier, try to eliminate them by using small weights to keep the fabric on the ground & prevent wind from lifting up.

4. Making a round curve to **CONTAIN** the water:



A - Completely unfold the Water-Gate.

B - Curve the Water-Gate as needed, making sure the back of the Water-Gate is not stretched.

C - Sandbags can be used to close off the spaces or folds formed by the Water-Gate ballast weights.

CONNECTING WATER-GATES TOGETHER

BOTH WATER-GATES MUST BE COMPLETELY UNFOLDED AT THE ATTACHMENT JOINTS.

All Water-Gates, regardless of size, can be connected together, except for the smallest 6in/15cm model, which can only be connected to barriers of the same size.

- A straight surface is required, especially under the joint where the two Water-Gates will be attached.
- Do not connect Water-Gates together in moving water. If the temperature is below freezing, the water in the velvet strips and hooks may freeze, making it impossible to connect Water-Gates together.
- It is recommended to have 2 people for this process, as one velcros the units together, the other is pulling on the ends to create tension for a smooth application.

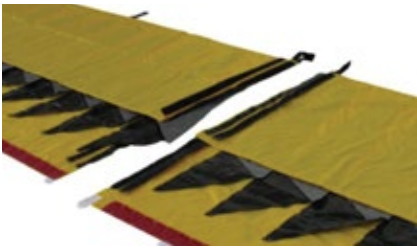

1. Completely unroll & unfold the 2 units to join. Lay the ends next to each other.

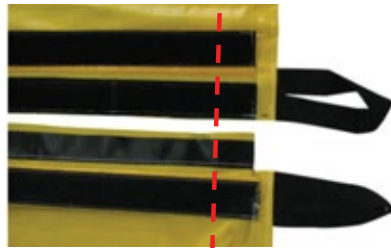

2. Make sure the back sides of the Water-Gates are even and the hook & loop fastening strips are fully unfolded & exposed.



3. Unfold the fabrics exposing the hook & loop fasteners. Insert one into the other. Be sure to smooth out without any folds or gaps.



4. Close up the hook and loop fasteners by laying them one on top of the other from the back.



5. Keep closing up the hook and loop fasteners by starting in the back and working to the front.



6. Repeat process with each layer, always working from back to front.



7. Close up the hook and loop fasteners by laying them one on top of the other, the same as you did for the bottom joint.

Use the same method to tie together two Water-Gates of different sizes. Follow standard instructions, the front edge will just be longer. Place a weight at these changes to prevent water infiltration.



SECURING THE ENDS OF THE WATER-GATES

The ends of the Water-Gates are not closed off, so they must be placed higher than the level of the anticipated water. Extra Water-Gate length may be needed for maximum safety.

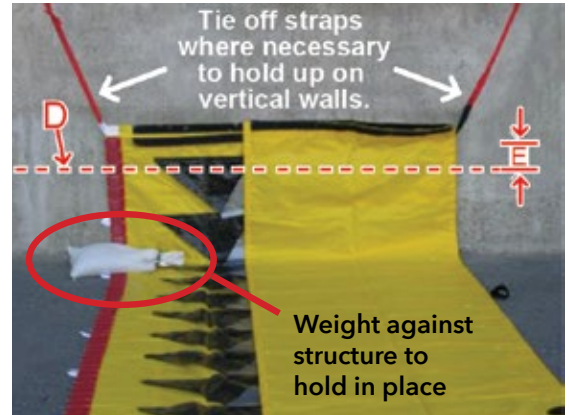

GOING VERTICAL ON A WALL

D = Flood water level or maximum water barrier opening.
E = Extra barrier length. We recommend a minimum extra length of up to 50% depending on the flood water level.

Every time the Water-Gate is lifted against a wall, a space is created and water will infiltrate from the corner. We strongly recommend placing one or more sandbags on that corner.

Lateral Handles: These PVC handles are fitted with the Velcro joining system and are convenient to fix the extremities when going up a wall or other supports.



PROTECTING AN ENTRANCE

If you decide to only protect the entrances instead of all the walls of your building, make sure that no water can seep in through the walls. The photograph shows weeping holes that could allow water to flow inwards. Such holes are found on all insulated brick walls. Make sure you fill in these small holes before the flood and clear them again after the flood.



ADHERENCE OF THE WATER-GATE WHEN INSTALLED ON A SMOOTH SURFACE

For smooth surfaces, place additional sandbags or weights along front of the Water-Gate.

Some exceptionally smooth surfaces, such as tarred asphalt or polished cement, require particular attention. Water stays trapped between the fabric at the bottom of the barrier and the smooth surface causing loss of surface tension. The result is similar to HYDROPLANING when driving with completely worn-down tires.

It is very important to understand what it takes to ensure that the Water-Gate adheres properly to the ground: **AT NO TIME SHOULD WATER ACCUMULATE UNDERNEATH THE WATER-GATE.**

ELIMINATION OF WATER INFILTRATIONS UNDER THE BARRIER

It is important to remove any object underneath the Water-Gate in order to prevent areas for water to infiltrate.



To eliminate the Water-Gate from lifting up in uneven areas, we recommend putting sandbags on the corners.



Be careful: When the flood water enters the Water-Gate, the fabric could retract and create new spaces allowing the water to flow under the barrier. It is best to check on the direction of the water flow and adjust weights and pumps accordingly.

IMPORTANCE OF NOT TYING TO THE GROUND

The Water-Gate tends to contract as it fills up with water. Tying down the Water-Gate will put tension on the front flap, which will create spaces for the water to flow through since the fabric cannot remain tightly against the ground.



IMPORTANCE OF HAVING WATER PUMPS

Excessive water behind barrier causes unbalance & buoyancy. We strongly recommend having a generator to power all your water pumps or having gas operated pumps. Without these water pumps, the accumulated water may infiltrate the property.

Accumulated water may come from:

- Rain hitting the back side of the barrier
- Down spouts collecting behind the barrier
- Water seepage through cracks & divets under the Water-Gate
- Backflows of drain pipes
- Wet ground becomes permeable

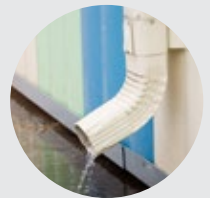

Be sure to leave at least 2 feet of space between the Water-Gate & the property to allow room for pumps.

It is hard to determine the number of pumps needed and their required capacity. For water getting through your dam, you will need a **pump with a capacity of 1/2 gal to 3.75 gal per min for each linear yard of dam.**



SPECIAL CONSIDERATIONS



High Wind: The Water-Gate can be installed, even in high wind

The Water-Gate can be kept on the ground in very strong wind, however, some additional precautions do have to be taken. To minimize the effect of gusting wind, keep the Water-Gate folded and add a sufficient number of sandbags or weights to keep it tight against the ground.

When the flood water arrives, ensure the Water-Gate is properly deployed, by pushing off any ballast weights that are in the way. The barrier can be unfolded and will automatically deploy.

If weights or sandbags are not available, staking down a porous fabric like a netting could be used. Water will pass through & begin to anchor the Water-Gate in place, then the netting could be removed.



CALCULATION OF INSTALLATION TIME

Units in a crate will be deployed at a nice rolling/walking speed to pull the Water-Gate out & lay on the ground.

If units need to turn a corner- fully deploy out the units in straight line & then create the corner once on the ground.



For speed of joining units, 2 people is preferred. One to pull & add tension, while the other attaches & smooths out the velcro from back to front each time.

Larger single units are provided wrapped in an outer sleeve with carrying straps & should be kept for both storage & deployment.



The table below shows the estimated time it takes to install a Water-Gate with a length of 50ft/15m.

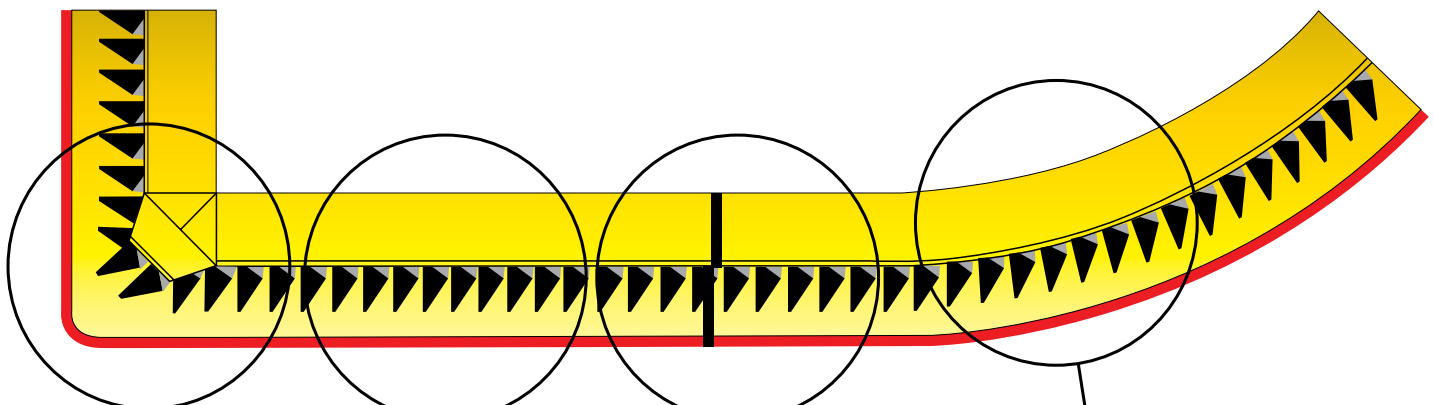

Barrier's size	Estimated time
WL-06	30 sec./ 1 pers.
WL-14, 20, 26	1.5 min./ 1 pers.
WL-39, 50	2 min./ 2 pers.
WL-60,78	3 min./ 3 pers.

Unroll the barrier in a straight line

Barrier's size	Estimated time
WL-06	1 min./ 1 pers.
WL-14, 20, 26	3 min./ 2 pers.
WL-39, 50	3 min./ 3 pers.
WL-60,78	4 min./ 3 pers.

Tying together two barriers

Barrier's size	Estimated time
WL-06	15 sec./ 1 pers.
WL-14, 20, 26	1 min./ 2 pers.
WL-39, 50	2 min./ 3 pers.
WL-60,78	3 min./ 3 pers.

Making a corner for angles 5° to 125°

Barrier's size	Estimated time
WL-06	1 to 2 min./ 1 pers.
WL-14, 20, 26	1 to 4 min./ 2 pers.
WL-39, 50	2 to 5 min./ 3 pers.
WL-60,78	3 to 7 min./ 3 pers.

Curving the barrier for angle less than 5°

FOLDING UP THE WATER-GATE FOR STORAGE

It is very important to fold each Water-Gate with flaps laying flat to ensure a long shelf life.

Folding the Water-Gate (model WL-1430 illustrated)



1 - After cleaning and drying the Water-Gate, stretch it out on a large flat surface.



2 - Make sure all inner flaps are facing the same direction & flat. A stick or pole may be used to help flatten.



3 - Before folding the Water-Gate, keep all the joints open to make it easier to tie a second Water-Gate to it, if need be.

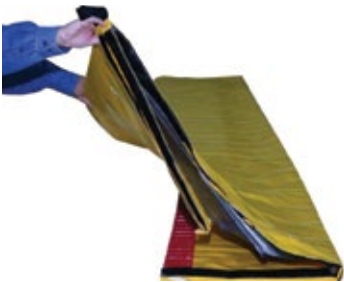

4 - Start folding from the back so that the ballast weights will be positioned in the middle and under the Water-Gate. Use the folds already appearing on the fabric as a reference.



5 - Depending on the model - the unit may need to be flipped over. If the instruction label is visible, flip the unit & roll from the opposite side of the label. If the label is not visible- lift up 1 end to find the label & then roll from the opposite end.



6 - Once rolled, the velcro straps will wrap around the unit & the label will be visible.

Please note that the folding pattern and number of folds differ for each size of barrier



WL-06 and WL-14 Model
1 fold only

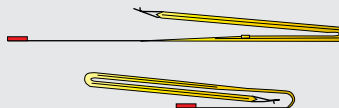

WL-20 and WL-26 Model
2 folds

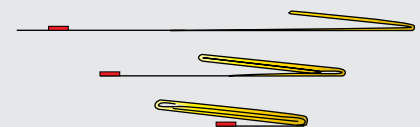

WL-39 Model
3 folds

MAINTENANCE

It is strongly recommended to wash and dry the Water-Gate after each use, before storing it. This allows you to check for any damages that may have occurred during use. Cleaning the product with a pressure washer or strong water hose is strongly recommended.

Caution: Storing away a Water-Gate unit that has not been cleaned & left with debris, leaves & moisture will cause damage to the fabric & reduce its useful life, as well as leave an unpleasant odor.



Place objects to raise Water-Gate to dry out, prior to storage

STORAGE & DEPLOYMENT

Every Water-Gate should be kept in its storage bag or crate for protection against UV rays, dirt, and damages, as well as easier handling during transport.

The Water-Gate can be piled one on top of the other, upright or flat, without this hampering their deployment. However, storing the Water-Gate in a vertical position is highly recommended to maintain its shape when rolled up. We don't recommend setting the Water-Gate directly on a damp surface. It is best to lay on a wooden pallet or any dry surface to eliminate mold.

Materials resist temperature of -40°F to 120°F (-40°C to 50°C). Even when stored for several years at these temperatures (maximum 10 years), the Water-Gate remains effective.

Rodents are not attracted to polymer canvas and will not chew this type of material.

REPAIRS

In the event that your Water-Gate has a tear or perforation, using contact cement & a repair patch from the inside may be all that is needed.

If that does not appear to be the solution, then we suggest contacting local sewing professionals to assist in a repair. They should have equipment suitable to manage canopies, canvas truck covers, tents, car shelters, shoe repair or something similar. If that is not an option, shipping the unit back to the manufacturer for repairs may be an option, but freight can be costly. Any damage (cracks/holes) resulting from sharp objects can be repaired, but these are not covered under the warranty.

WARRANTY

Each Water-Gate is manufactured and inspected according to strict quality standards. A registration number is printed on the ends of each Water-Gate, which is warranted against all manufacturing defects for a period of 2 years. Fabric materials are UV coated & have a 20 year shelf life with normal occasional use.

STORAGE DEPLOYMENT CRATES



Storage & Deployment crates are critical for areas that need multiple units & a quick way to deploy them. Each crate is custom designed for each customer application.

We offer wood or steel, fork lift or wheeled & can accommodate custom requests.

TECHNICAL FABRIC SPECIFICATIONS

The technical specifications in the chart below are minimum requirements for all specified properties.

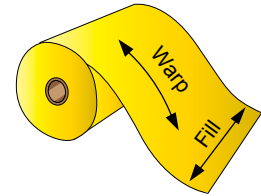

PVC Fabric	For models WL-06, WL-14, WL-20 & WL-26		For models WL-50 and WL-60	
Properties	Minimum Specifications	**Certified	Minimum Specifications	**Certified
Weight	610 g/m² - 18 oz yd²	Yes	750 g/m² - 22 oz yd²	Yes
Base Fabric	Woven polyester scrim	-	Woven polyester scrim	-
Tension resistance *	Warp 40 kg/cm 245 lbs/in Fill*** 35 kg/cm 218 lbs/in	Yes	Warp 55 kg/cm 310 lbs/in Fill*** 50 kg/cm 275 lbs/in	Yes
Tear resistance	Warp 32 kg 72 lbs Fill*** 22 kg 49 lbs	Yes	Warp 45 kg 100 lbs Fill*** 35 kg 80 lbs	Yes
Adhesion	Warp 1.5 kg/cm 8 lbs/in Fill*** 1.5 kg/cm 8 lbs/in	Yes	Warp 1.5 kg/cm 8 lbs/in Fill*** 1.5 kg/cm 8 lbs/in	Yes
Heat resistance	-30° +70°C / -22° +160°C	Yes	-30° +70°C / -22° +160°C	Yes
UV resistance	More than 80% strength retention after 2000 hours of exposure	No	More than 80% strength retention after 2000 hours of exposure	No
Flame resistance	Not applicable	No	Not applicable	No

Polyethylene woven fabric	For models WL-06, 14, 20, 26		For models WL-39, 50, 60	
Properties	Minimum Specifications	**Certified	Minimum Specifications	**Certified
Weight	200 g/m²- 6 oz yd²	Yes	300 g/m² - 9 oz	Yes
Base Fabric	100% polyethylene		100% polyethylene	
Tension resistance *	Warp 34 kg/cm 210 lbs/in Fill*** 30 kg/cm 185 lbs/in	Yes	Warp 80 kg/cm 490 lbs/in Fill*** 50 kg/cm 320 lbs/in	Yes
Tear resistance	Warp 31 kg 68 lbs Fill*** 31 kg 68 lbs	Yes	Warp 40 kg 88 lbs Fill*** 40 kg 88 lbs	Yes
Resistance to cold temperature	-40°C / -40°F	Yes	-40°C / -40°F	Yes
UV resistance	More than 80% strength retention after 2000 hours of exposure	Yes	More than 80% strength retention after 2000 hours of exposure	Yes
Flame resistance	Not applicable	No	Not applicable	No

Lbs/in. = Pounds/inch = lbf

yd² = square yard

g/m² = GSM

* Tension resistance or grab tensile

** Certified = tested according to recognized standards

*** Fill or Weft

BEHAVIORS AND STRETCHING OF THE PARTITIONS

The partitions of the Water-Gate are made of non-expandable polyethylene, a rigid material recognized for its strength. These partitions prevent the upper canvas from tipping backwards via the components principle of equilibrium of forces.

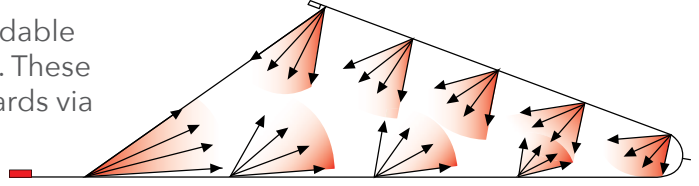

PRESSURE EXERCISED ON ANY PART OF THE PARTITIONS

In this illustration, we can observe the pressure exerted on each part of the partition. The red indicated the robustness to tension applied on each partition.

We can observe an area which has a point of force superior to any other. It is here on the partitions that receive the most tension. It is also at a point which our calculations of strength and sturdiness have been made.

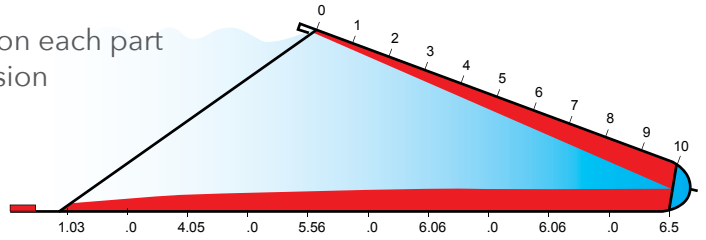

The tensions inscribed on the canvas are figures based on our expertise and our observations.

DISCHARGE OF WATER DUE TO THE PRESSURE

The gray part on the drawing represents the partition. The rounded design on the back side limits the swelling of the rear portion of the Water-Gate and forms a single unbroken line with the upper part of the canvas. Thus preventing any weakening which could create a tear from the wall. (The rounded part "Arc" is small enough not to create tension on the point "from the seam of the partition").

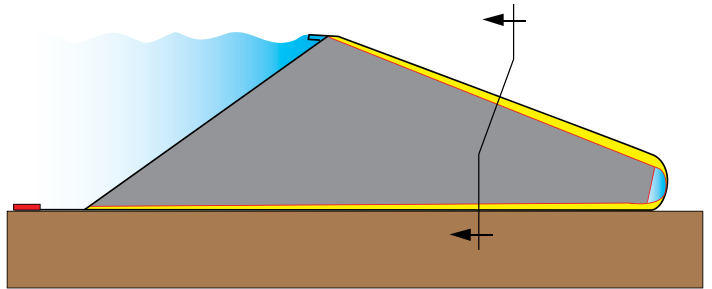

The pressure exerted on the upper canvas raises the partitions leaving a discharge space so that the incoming water is not trapped below the surface of the Water-Gate.

CALCULATION OF THE PRESSURE

Since we know the highest points of tension exerted on each partition, we can calculate the force exerted in order to ensure that the partitions resist more than 3 times the pressure of the water (a norm established for Water-Gate products) to insure a very safe and reliable product.

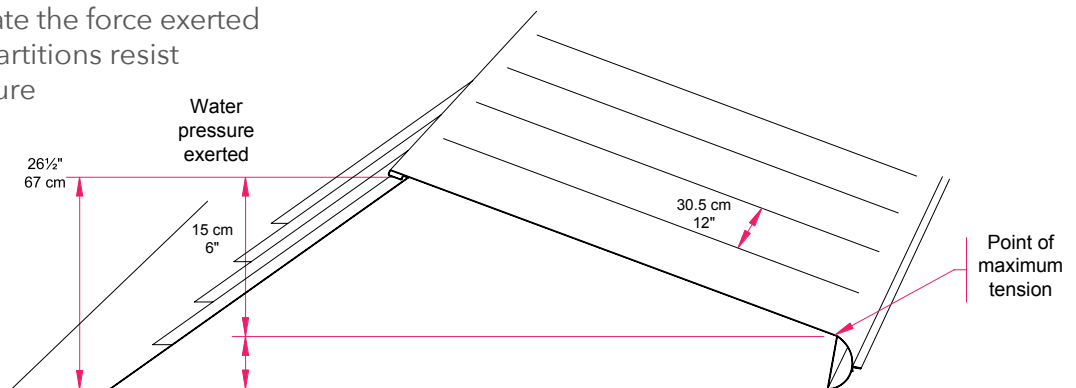

ENVIRONMENTAL FOOTPRINT

Water-Gate products are manufactured with material that can be recycled, decreasing the environmental impact.

Ground Sheet & Retention Tarp

PVC Coated Polyester

4%



Holding Partitions

Polyethylene Fabric

13%



Ballast

Steel Plates

26%



Sewing thread & Velcro Strips

Polyester

4%



Straps

Polypropylene

2%

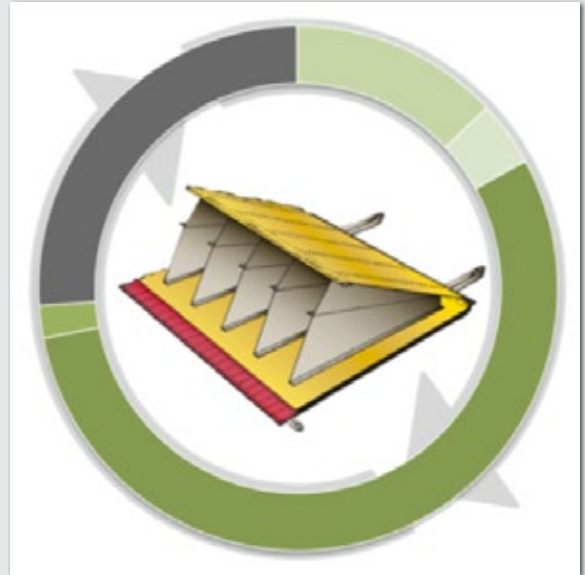

FREQUENTLY ASKED QUESTIONS:

What happens if debris in and on the water run into the Water-Gate?

The Water-Gate system is soft & flexible & flows with water. Floating debris will hit the Water-Gate & bounce back into the water causing no harm to the Water-Gate or some debris may hit & float over the top & end up behind the barrier. In either case the Water-Gate system will still hold back the water.

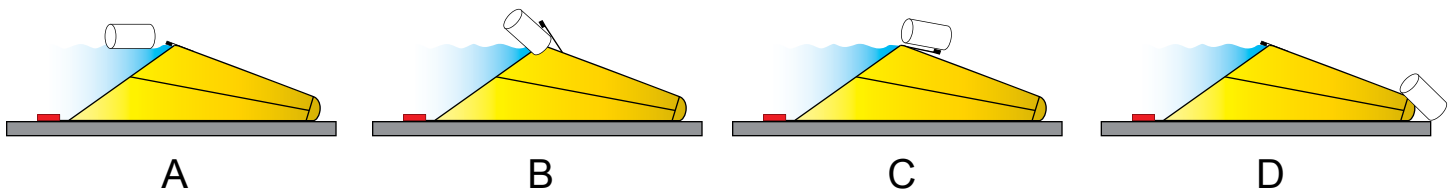

If a wall or a tree falls on the barrier during a flood, what solution do you propose?

The Water-Gate will simply wrap itself around the object that fell on it and only a small amount of water will go over the Water-Gate. All you have to do is remove the fallen object, and the Water-Gate will regain its original position. The risk of tears from an object falling on the Water-Gate is pretty low. Should there be a hole or a tear, it can easily be repaired by placing a piece of fabric inside the Water-Gate. The fabric will adhere to the inside wall simply from the pressure of the water entering the Water-Gate.

What skills are required for installation? Is training necessary?

No particular skills are required. However, basic training is recommended. Installation is simple but does require a minimum of understanding. Chances are you will find everything you need to know in this manual. If you have any questions after going through it, a technician will be happy to give you more information.

Can the Water-Gate system open up fast enough to stop waves?

The Water-Gate will open at the same speed as that of any waves coming in. This means that regardless of the speed of the oncoming water, the Water-Gate will open up like a parachute does in the wind. However, if a wave has white caps on top of it, the surplus of water will go over the Water-Gate and will need to be pumped. To contain all types of waves, Water-Gate must remain open; There are small holes at the base and at the top of the partitions in which stiff rods can be inserted to keep the barrier open at all times. A pool noodle float can also be looped into the Water-Gate to keep the upper edge floating.



If the flood is a mudflow, and huge rocks get dragged down, will the Water-Gate withstand the flood?

Yes, the water barrier can withstand the pressure from a mudflow. The Water-Gate is at least three times stronger than required. Given the fact that the density of thick mud is approximately 1.65, the safety margin is excellent.



As far as the presence of large rocks is concerned, at the beginning, there is more water than mud and there are no rocks. Medium size rocks are typically found upstream

and larger rocks are even further upstream. Based on our expertise, we know that the barrier will first fill up with relatively thin

mud. Medium size rocks will arrive next. The larger rocks will only be found at the end and will never reach the Water-Gate. Because of this, a mudflow will not compromise the safety of the Water-Gate.

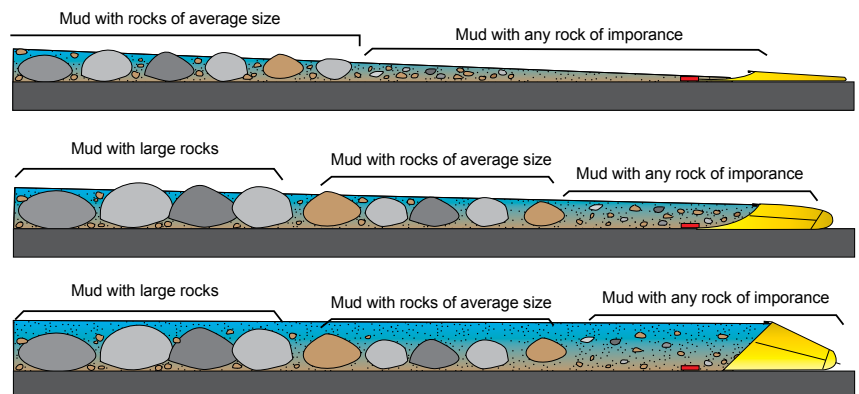

Illustration		
A	Mud with medium rocks	Mud with no large rocks
B	Mud with large rocks	Mud with medium rocks
C	Mud with large rocks	Mud with no large rocks

If the Water-Gate is left for several months or even several years in a stream, will it stay in place during that period?

Yes, the Water-Gate will stay in place provided the water level is not much higher than the top of the Water-Gate. Do not forget that the flow of a stream never remains the same due to alternate periods of drought and abundant rainfall. Also, in northern areas, the water barrier can be moved by moving ice.

Observation: If the Water-Gate remains in a stream for a month or longer, a light coat of silt will form inside, on the fabric at the bottom of the immersed Water-Gate. After four months, only 50% of the fabric will remain visible due to the thickness of the silt.

Will the Water-Gate withstand parallel water flow?



Parallel water flow is not a problem. In the photo, there was more water flowing than the Water-Gate intended to withstand, and the current was swift. In the same trail with lots of parallel flowing water, we attempted to damage the Water-Gate with wood fragments. Our testing process was rigorous but did not result in any damage to the Water-Gate.

What about leaks from the Water-Gate system?

All flood control systems have some type of seepage. You should expect the Water-Gate to have seepage.

Seepage rates can vary & improve as more water arrives. Example:
Barrier with 4in (10cm) of water = seepage of 1 Gal/min/linear foot.
Same Barrier with 20in (50cm) of water = seepage of 1/2 Gal/min/linear foot.

If the water barrier is laid down on a regular asphalt surface, with 4in (10 cm) of retained water, the size of the leaks can be around 1 Gal/min/linear 3ft. However, if the barrier retains 20in (50cm) of water, only about 1/2 Gal/min/ 3ft will leak from it.

Your emergency plan should definitely include pumps to remove any water leaking through the Water-Gate as well as from rain, down spouts, drainage back flows & anything else that may put water in unwanted places. We recommend using gas powered water pumps that do not depend on electrical power and plan for leaks that may be greater than the amount of water expected to flow under or appear around the barrier.



Will the Water-Gate barrier withstand freeze-thaw cycles?



Our PVC fabric manufacturer warrants its products against cracking at a temperature of -22° F (-30° C), and the polyethylene partitions are guaranteed to withstand temperatures as low as -40° F/C.

The PVC fabric and polyethylene used to make our barriers are the same as those used for road transport and car shelters. They are very resistant to extreme temperatures and have proven their worth over several decades of freeze-thaw cycles.

The water barrier in the photograph was placed in a stream at a temperature of -4° F (-20° C) for a period of three days. A layer of ice formed on the inside, at the top of the PVC (yellow) fabric, but was very easy to remove by just tapping the barrier. The ice came unstuck, immediately floated to the top of the barrier, slid over it and ended up behind it.

For more FAQs, please visit QuickDams.com

Notes

Inspection & Maintenance

Usage & Maintenance Log



PROTECTING THESE INDUSTRIES

- 
Government
 - 
Property Management
 - 
Construction
 - 
Universities
 - 
Hospitals
 - 
Janitorial
 - 
Hotels
 - 
Retail
 - 
Grocery
 - 
Residential
- & MORE**

Visit us at www.quickdams.com or call 888-761-4405



QD_Water-Gate_manual_20210106

